

Parts List

Part Number	Qty.	Description
11431	1	Cord
15531	4	Grommet
91443	1	Strain Relief
91553	2	10/16 x 3/4" Self Tapper
D1736	4	10/32 Bolt
N0107	4	10/32 Nut
N0109	4	#10 Washer
N0050	16	1/4-20 Nylock Nut
N0052	8	1/4 Washer
H0084 or H0085		120V or 240V Motor Brush Set
H0234	2	Locator Pad Bumper
H0236	1	3/8-16 x 15" All Thread Rod
H0237	1	3/8-16 Rivet Nut
N0050	4	1/4-20 Nut
H0244	4	1/4-20 x 9" Rod
H0246	1	3/8-16 Wing Nut
H0263	1	Hex Nut
H0291	3	10/24 x 1/2" Screw
H0292	4	10/24 x 3/4" Screw
H0293	3	10/24 Nylock
H0297	4	5/16-18 x 1/2" Screw
H0952	1	Foam Float
H0953	1	Filter
H0955	1	Shroud
H0956	1	Lid
H0957	1	Cap
H0958 or H0940	1	120V or 240V Motor
H0960	2	Handle
H0961	1	Filter Mounting Cage
H0963	1	Filter Support
H0964	2	Locator Pads
H0108	1	Lid Seal
H0968	1	Switch
H0972	1	Motor Support Plate
H0974	1	Intake Port

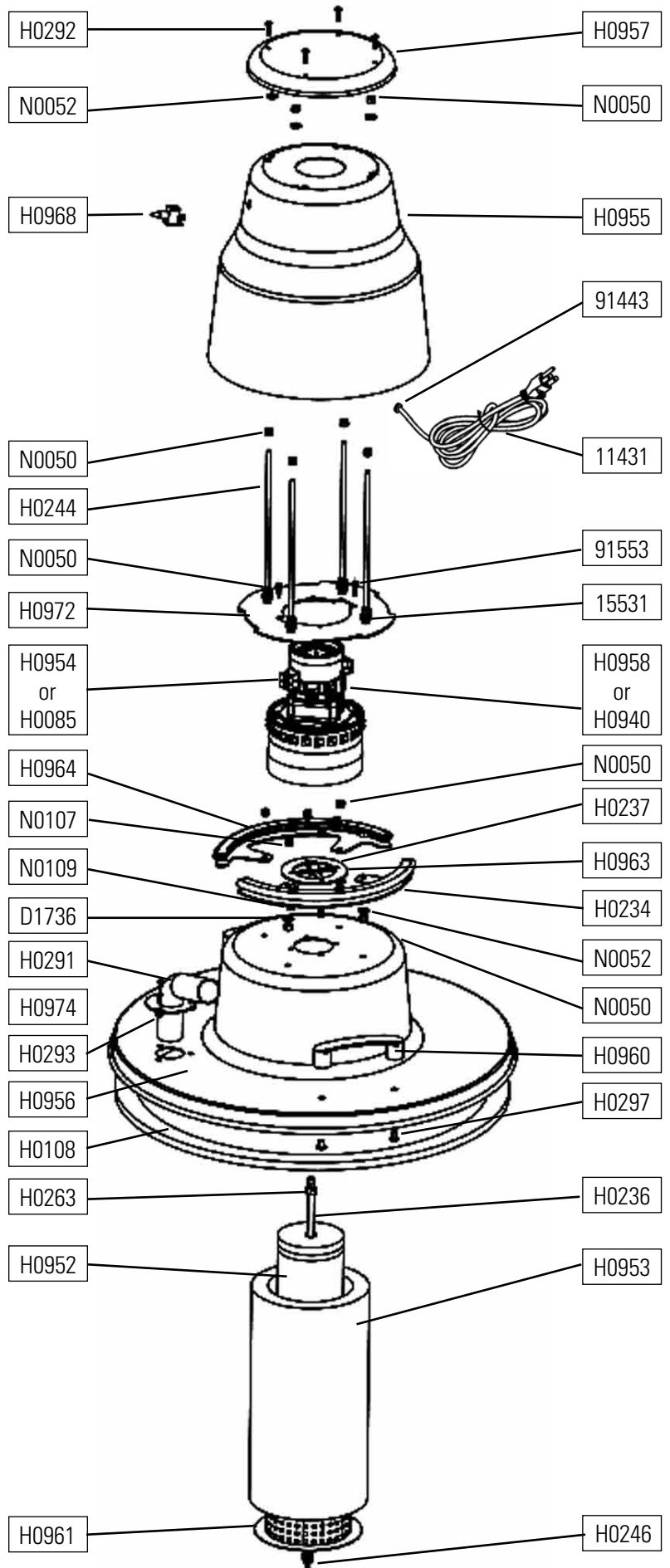

Slurry Vacuum™

OWNER'S MANUAL



Write your serial number and circle your model number below for your records. Serial numbers are found next to the plug. You should record both numbers in a safe place for future use.

Serial Number _____

Model Numbers:

- | | |
|-------|--------------------------|
| H0901 | 120v SlurryVacuum |
| H0902 | 240v SlurryVacuum |
| H0904 | 120v SlurryVacuum Kit |
| H0905 | 240v SlurryVacuum Kit |
| H0903 | 120v SlurryVacuum Topper |
| H0906 | 240v SlurryVacuum Topper |

WARRANTY:

THREE-YEAR LIMITED WARRANTY – At Dustless Technologies, we stand behind what we build. We warranty this product, to the original retail purchaser, against defects in materials or workmanship for a period of (3) three years after date of purchase.

This limited warranty does not cover claims resulting from: (I) misuse (II) neglect (III) modification (IV) failure to follow instructions.

Warranty Card - Please, fill out your warranty card online at dustlesstools.com. Please fill out your warranty card within 90 days of purchase.

Warranty Claims - For warranty or returns with any of our products, please contact your place of purchase. Technical support is available at (800) 568-3949 or send an email to orders@dustlesstools.com.

IMPORTANT SAFETY INSTRUCTIONS

IMPORTANTES MEDIDAS DE SEGURIDAD

IMPORTANTE PARA SU SEGURIDAD

SAVE THESE INSTRUCTIONS

CONSERVE CES INSTRUCTIONS

GUARDAR ESTA INSTRUCCIONES

NOTE: The reading and understanding of the Owner's Manual is imperative prior to operating this machine. If you or your operator(s) cannot read English, have this manual explained fully before attempting to operate this machine. Si Ud. o sus operadores no pueden leer el inglés, el contenido completo de este manual será explicado antes de intentar operación de esta máquina.

Read the Owner's Manual completely before attempting to operate this unit. Failure to follow the warnings and instructions may result in burns, fire, electric shock, or personal injury:

Work Area Safety

- Do not operate vacuum in explosive atmospheres. Sparks from static electricity or the motors may ignite dust or fumes.

Electrical Safety

- Connect to a properly grounded outlet. See grounding instructions.
- Always unplug unit when not in use and before servicing.
- Electrical parts of this vacuum may only be worked on by a skilled electrician and in accordance with the electrical engineering regulations.
- Do not handle plug or operate vacuum with wet hands.

Personal Safety

- Do not allow to be used as a toy. Close attention is necessary when used by or near children.
- Do not change filters, clean the unit, or empty the tank until the plug has been disconnected from the electrical outlet.
- Use special care when emptying heavily loaded canisters.
- Keep hair, loose clothing, fingers and all parts of body away from openings and moving parts. There is a risk of injury through getting stuck or being drawn into moving machinery.
- Use extra care when working on stairs.
- Injury to the eyes and or body can occur if protective clothing and or equipment is not worn. Always wear safety goggles, protective clothing, hearing

Grounding Instructions:

This appliance must be grounded. If it should malfunction or breakdown, grounding provides a path of least resistance for electric current to reduce the risk of electric shock. This appliance is equipped with a cord having an equipment - grounding conductor and grounding plug. The plug must be inserted into an appropriate outlet that is properly installed and grounded in accordance with all local codes and ordinances.

WARNING - Improper connection of the conductor can result in a risk of electric shock. Check with a qualified electrician or service person if you are in doubt as to whether the outlet is properly grounded. Do not modify the plug provided with the appliance

protection, and a dust mask. Exposure to high noise levels can cause hearing loss or impairment. Wear OSHA-approved hearing protection when using this vacuum.

Tool Use and Care

- Always check the filter before each use. Do not use without filter in place.
- Do not use with damaged cord or plug.
- Do not use if vacuum is not working as it should.
- Do not pull or carry by the cord, use cord as a handle, close a door on cord, or pull cord around sharp edges or corners. Do not run vacuum over cord. Keep cord away from heated surfaces.
- Do not unplug by pulling on cord. To unplug, grasp the plug, not the cord
- Turn off all controls before unplugging.
- Changes, add-ons, or conversions of the vacuum which might have an influence to the safety of the vacuum must not be undertaken without the permission of the manufacturer. This applies in particular to the fitting and adjustment of safety devices and to welding on major and load bearing parts.
- Spare parts must always comply with the technical requirements and the specifications of the manufacturer. This is always guaranteed with original spare parts from the manufacturer.
- In the event of operational malfunctions the vacuum must be shut down immediately. The malfunction must be rectified before starting the vacuum again!

Service

- Adjustments, servicing, and inspection work and inspection intervals specified in these Operating Instructions, as well as any information on the replacement on parts and systems of the vacuum must be undertaken and complied with.
- These activities can only be undertaken by qualified personnel.
- Make sure that electrical components used for replacement purpose comply with the original parts and are correctly adjusted if necessary.
- Before performing any maintenance, place the vacuum in the safety off position which is the position of the vacuum when it cannot generate any hazard.

Specific safety rules

- This vacuum is for WET RECOVERY only.
- Do not use to pick up flammable or combustible liquids, such as gasoline.
- Do not pick up any objects that are burning or smoking, such as cigarettes, matches or hot ashes.
- Please handle in accordance with the regulation of how to dispose of the liquid so that you meet the requirements of local regulations
- WARNING** - to reduce the risk of shock - Do not use on wet surfaces. Do not expose to rain. Store indoors.

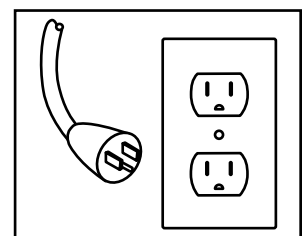

Extension Cords

Volts		Total Length of cord in feet			
120V		25	50	100	150
Ampere Rating		AWG			
More Than	Not More Than				
0 - 6		18	16	16	14
6 - 10		18	16	14	12
10 - 12		16	16	14	12
12 - 16		14	12	Not Recommended	

When using the appliance at a distance where an extension cord becomes necessary, a 3-conductor grounding cord of adequate size must be used for safety, and to prevent loss of power and overheating. Use the table to the left to determine A.W.G. wire size required. To determine ampere rating of your vacuum, refer to nameplate located on rear of motor cover. Before using appliance, inspect power cord for loose or exposed wires and damaged insulation. Make any needed repairs or replacements before using your appliance. Use only three-wire outdoor extension cords which have three-prong grounding-type plugs and three-pole receptacles which accept the extension cords plug. When vacuuming liquids, be sure the extension cord connection does not come in contact with the liquid.

NOTE: STATIC SHOCKS ARE COMMON IN DRY AREAS OR WHEN THE RELATIVE HUMIDITY OF THE AIR IS LOW. THIS IS ONLY TEMPORARY AND DOES NOT AFFECT THE USE OF THE APPLIANCE, TO REDUCE THE FREQUENCY OF STATIC SHOCKS IN YOUR HOME, THE BEST REMEDY IS TO ADD MOISTURE TO THE AIR WITH CONSOLE OR INSTALLED HUMIDIFIER.

Setup

1. Unpack and Check Box Contents:

Remove entire contents of box. Check each item against the Parts List. (pg. 4)
Notify Dustless Technologies® immediately if any parts are damaged or missing.

2. Install Rod and Float:

Place upside down on a flat surface.

Tighten with wrench

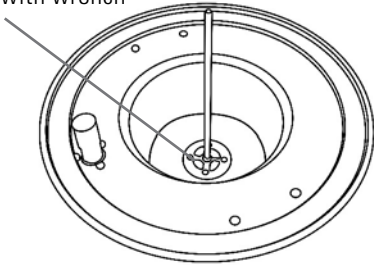

Thick foam down

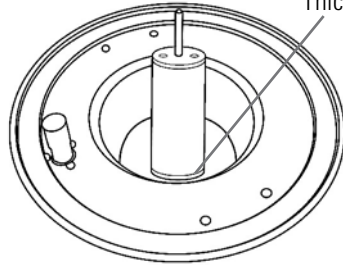

3. Wrap Filter around Filter Cage.

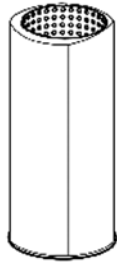
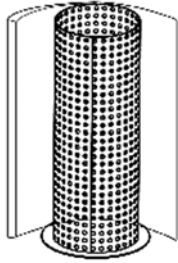
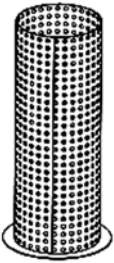

Thick foam down

4. Place the Filter Cage, Filter and Wing Nut over the Float.

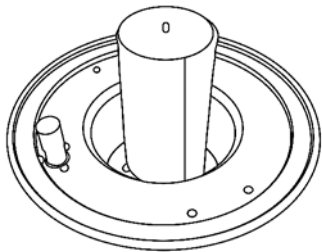

Tighten Wing Nut

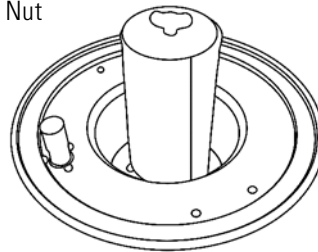
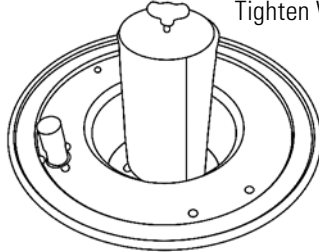

How to Use

Operation:

Place vacuum on drum. Push hose onto the intake port. Plug in vacuum.

The on/off switch is located on the shroud below the cap.

Do not operate vacuum without float or filter in place

When the drum is full of liquid, the automatic shut-off mechanism will shut off air flow. When this happens, the motor sound will become

noticeably higher in pitch. Turn cleaner off and empty or replace drum to continue use.

Storage:

Disconnect from electrical outlet. Remove from drum. Store in a dry location indoors. Wrap the cord carefully around the vacuum to avoid accidental damage.